



Primrose Awnings Half Cassette Manual & Electric Instructions

Contents for 2.5m, 3m Awnings

4 x Expansion bolts (2 per bracket)**
2 x Wall brackets□
1 x Awning

Contents for 3.5m, 4m Awnings

6 x Expansion bolts (2 per bracket)**
3 x Wall brackets□
1 x Awning

Contents for 4.5m Awnings

8 x Expansion bolts (2 per bracket)**
4 x Wall brackets□
1 x Awning

Optional Controls

(Depends which set was purchased)

Set A (Remote control kit)

1 x Remote control receiver box
2 x Remote hand-held zappers
1 x 5m electrical wire (3 core) to connect
the remote receiver box to the mains

Set B (Indoor wall switch)

1 x Wall Switch

Set C (Wind, sun, rain sensor)

1 x Remote control receiver box
2 x Remote hand-held zappers
1 x Wind, rain and sun sensor

WARNING

We recommend that two people are required to lift the awning into place.

You may wish to consult a qualified electrician before installing electrical awnings.

The awning and frame may be supplied with a plastic wrapper. This should be removed prior to use.

Plastic bags can be dangerous to children and babies. Keep out of the reach of babies and children to avoid the risk of suffocation.

Tools recommended

- Hammer drill
- 14mm masonry drill bit
- Chalk or pencil to mark
- Laser level or long spirit level
- Metric socket spanner set
- Adjustable spanner

**The expansion bolts supplied are for reinforced concrete or brick walls. The awnings may be installed on wooden walls if the wall is sufficiently strong. Use appropriate screw-threaded or coach bolts.

STEP 1: Determine position on the wall and mark up

Height of awning

The recommended height from the ground is 2.5m-3.5m. If you wish to install lower than this, determine whether there is sufficient headroom when the awning is fully extended and that any doors can open:

Required headroom

- Allow 20cm above any door frame and check that when opened the door will not interfere with the awning.
- As a guideline, the awning has a drop of 30 cm (2m projection) to 45cm (2.5m projection) at a slope of 10 degrees below the horizontal.

The recommended slope is factory pre-set. This can be adjusted with a spanner any time after fitting: from almost horizontal to approx 30 degrees below the horizontal.

Horizontal positioning of brackets:

Using laser, spirit level or other method, mark an accurate horizontal line at the required height. Fixing must be directly into brick or concrete. Mortar joints between the bricks or blocks will not be secure enough to bolt into.

Half cassette and electrical awnings

The bracket positions of Half cassette awnings are factory pre-set: the left-to-right positions of the brackets in relation to the awning can only be adjusted a few mm in either direction.

(If this is a problem, our Standard Manual awnings have more flexibility as to the left-right positioning of the brackets)

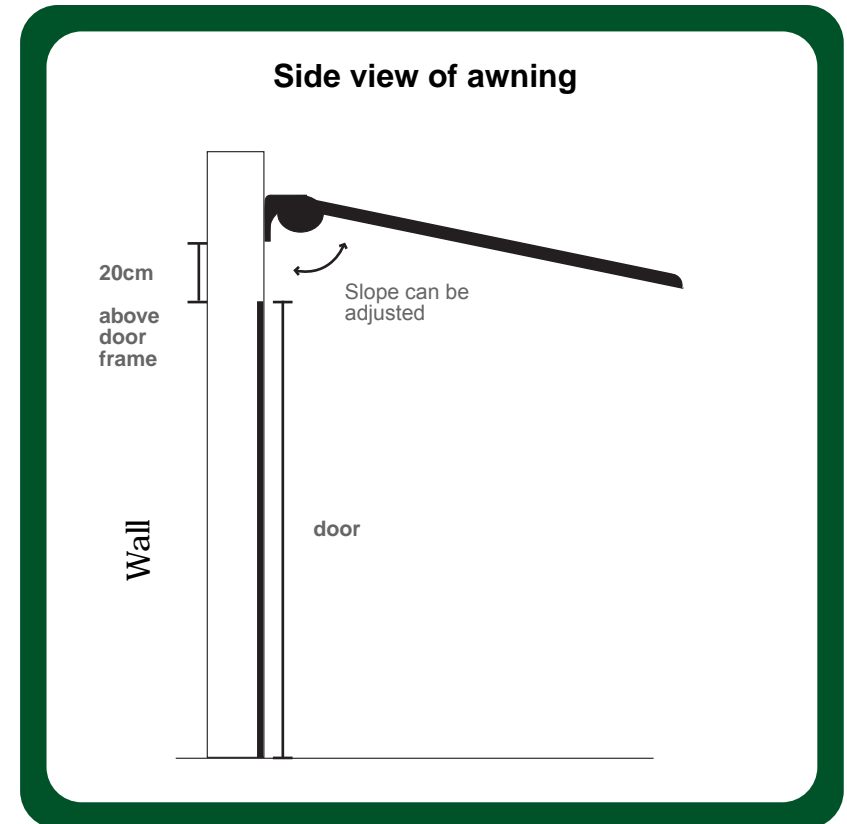

STEP 2: Drill holes

Use a hammer-action electric drill with a 14 mm bit.
Drill 100mm holes into brick or concrete wall in exact position chosen for wall brackets.
Insert an expansion bolt into the drilled hole.

STEP 3: Attach the brackets

Remove the nut and one of the washers from the expansion bolts that are now on the walls.

Fit bracket into place over wall bolt. Replace the washer and nut and tighten with a socket spanner. Ensure the bracket is tight against wall before fitting the awning as the weight of the awning could pull the brackets out of the wall.

STEP 4: Fitting the awning

Because the awning is heavy, we recommend 2 step ladders and two people.
Lift the awning unit into place on the wall brackets.

Fix the retaining bolts through the wall brackets to secure the awning unit in place.
Fit the nut onto the bolt and tighten.

Check that both the wall bracket and the retaining bolts are tightened securely.

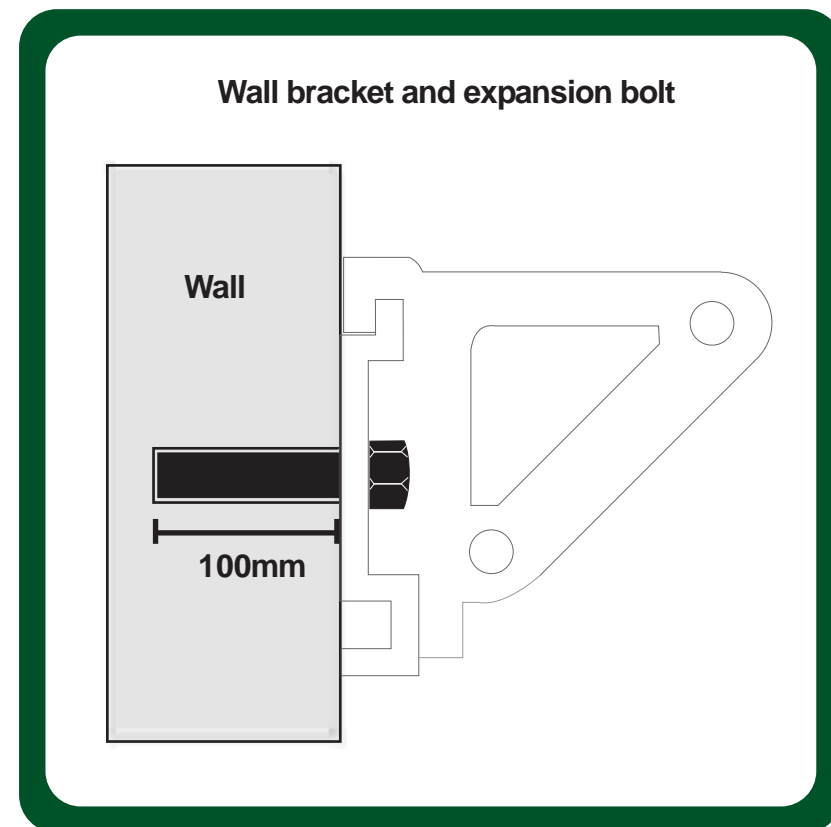

STEP 5: Wiring the electrics (THIS STEP APPLIES TO ELECTRIC AWNINGS ONLY)

Our awnings can either be plugged into the mains socket, or they can be wired into the mains. The following summarises how the wiring works for the Remote Control Kit and also the Indoor Wall Switch.

A. Remote Control Kit:

Electrical components:

- 1 x Receiving box
- 2 x Handheld Transmitters
- 1 x 5m electrical wire (3 core) to connect the receiver box to the mains

If you've purchased a wind, sun and rain sensor please refer to the instructions included with the sensor and disregard the illustrations on the right.

The remote control receiver box should be positioned indoors or within a waterproof box.

1. Connect the 4 core cable from the awning to the main receiver box (LREN)
2. Connect the 3 core cable (Mains) to the receiver box (LNE). The 3 core cable from the remote receiver box can now be wired into a standard 13 Amp plug and then plugged in to an existing socket. You can also wire directly into the mains, complying with any relevant regulations. If you are unsure of these regulations, we recommend you consult a qualified electrician.

Please refer to figures 1 and 2.

Programming remote zapper:

Normally, the zappers will be preset in the factory. This will mean that you can simply press the buttons to activate the awning. If this is not the case, perform the following procedure to program the zappers: Press down and hold the learning key. The green light will start to flash, while the light flashes press "UP" button on the zapper. Setup is now complete.

Figure 1

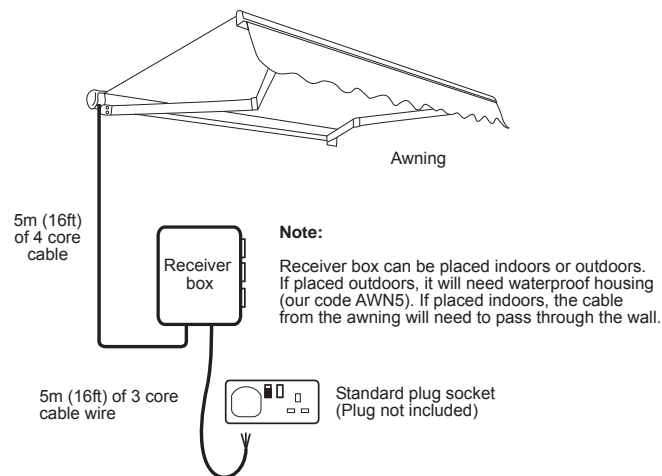
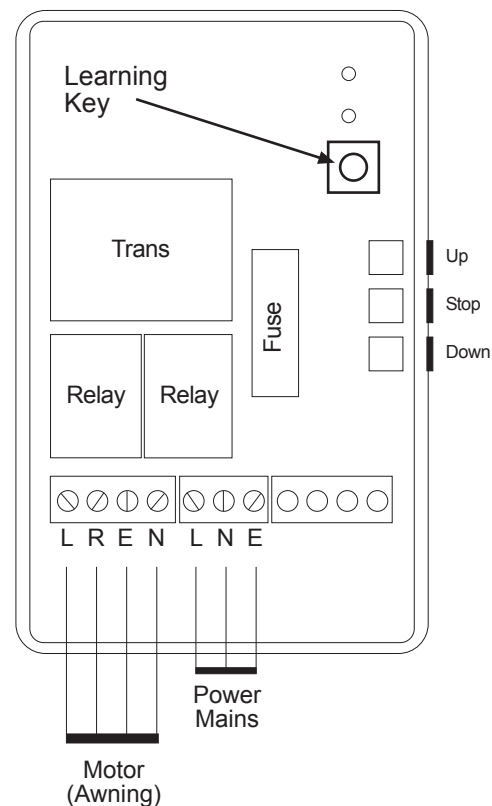

Figure 2



Connections:

Motor (Awning) wires:

- L= Direction #1 (Brown)
- R= Direction #2 (Black)
- E= Earth (Green & Yellow)
- N= Neutral (Blue)

Power Mains:

- L= AC Live (Brown)
- R= AC Neutral (Blue)
- E= AC Earth (Green & Yellow)

Remote Control:

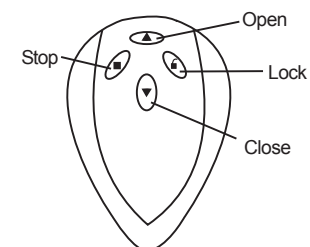

B. Indoor Wall Switch:

Electrical components:

1 x Wall Switch

Your awning will have **5 metres of 4 core cable**. The cable contains two separate circuits- one circuit for opening the awning and one for retracting it.

The **4 core cable** from the awning must be connected to the wall switch. Then run a standard mains cable (3 core cable) from the wall switch. Please refer to Fig. 3

STEP 6: Ensure the awning is level when fully extended.

The built-in spirit level in the front bar will show you if the front bar is level. The air bubble should be precisely in the centre. If the awning is not level when fully extended, adjust the slope of one arm - see Adjusting the Slope (below).

Although level when fully extended, the awning may not be perfectly level when fully retracted – this is normal.

Adjusting the slope (if required)

The optimum slope angle (approx 10 degrees from the horizontal) is pre-set at the factory.

It can be adjusted by loosening the 17mm locking nuts on both sides of the arms and then turning the 13mm jack bolts to the desired angle. Check the built-in spirit level in the middle on the front bar of the awning. Damage could result if the front bar isn't horizontal. Securely tighten the 17mm bolts.

Figure 3

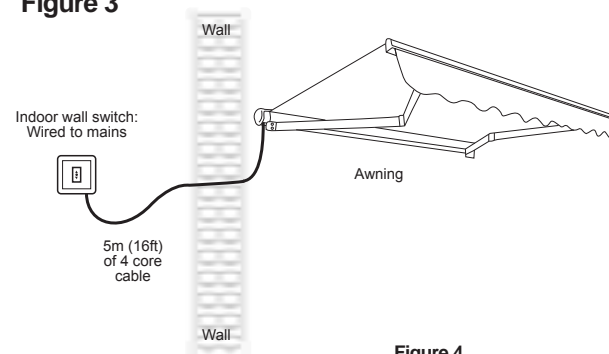
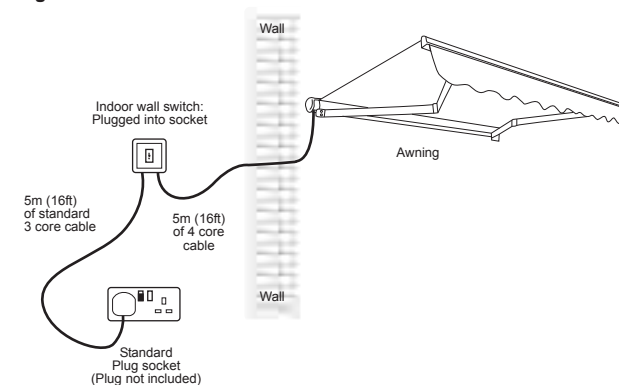
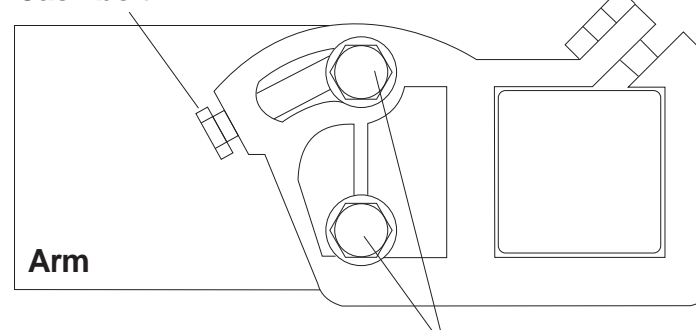

Figure 4



Jack bolt



Locking nuts

Adjusting the slope (if required)

The optimum slope angle (approx 10 degrees from the horizontal) is pre-set at the factory.

It can be adjusted by loosening the 17mm locking nuts on both sides of the arms and then turning the 13mm jack bolts to the desired angle. Check the built-in spirit level in the middle on the front bar of the awning. Damage could result if the front bar isn't horizontal. Securely tighten the 17mm bolts.

STEP 7: Can I control how far out the awning opens?

Manual awnings

With the manual awnings, you can control the position of the awning by simply winding out as far you want to go. The awning will hold at whichever position you wind to.

Electric awnings

The electric awning will stop automatically at the pre-set maximum extension. It will also stop automatically when fully retracted. If you wish, you can position the awning at any point between maximum extension and fully retracted by pressing the stop button while the awning is extending or retracting.

Adjusting the pre-set maximum extension and fully-retracted positions.

On the left hand end of the rotating barrel are two small hexagonal bolts marked by directional plus and minus signs. Rotate these bolts gently with a hexagonal key to change the maximum extension and full-retraction points.

1. Fully-retracted point. Take care not to set this to over-retract otherwise the awning may be damaged. Rotating towards the negative will reduce the amount that the awning retracts. If you wish to set the awning so that it retracts further, we recommend that you fully retract the awning with the current setting allowing the motor to turn off automatically. Then turn the hexagonal key and one quarter turn at a time towards the positive. This should cause the front bar automatically to move in a small amount to the new setting, enabling you to fine tune without risking damage to the awning due to over retraction.

2. Fully-projected point

General Care & Precautions

The awnings are constructed from weather resistant powder-coated metal and hard-wearing polyester fabric, and are designed to give many years of service. Stains and bird droppings etc. can easily be washed or sponged away, and should not be left for prolonged periods. The awning should always be retracted in severe weather conditions.

Guarantee

This awning is guaranteed against faulty parts and workmanship for one year from the date of delivery. Faulty parts will be replaced or exchanged within that period. The guarantee covers domestic use only.

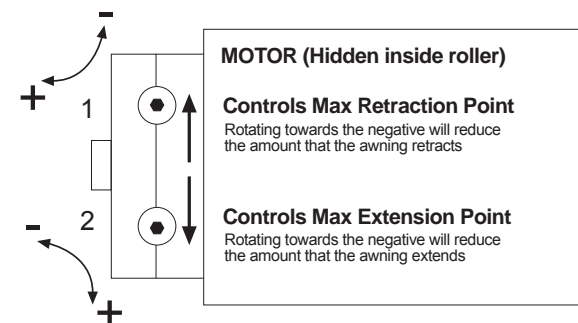

Made in China for Meika Ltd
www.primrose-london.co.uk Meika Ltd Co Reg 4756556
5a Stadium way, Reading RG30 6BX 0870 499 0220