







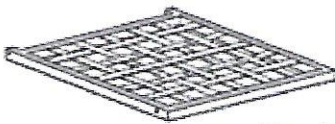

Harvington Bench and Cushions:

Parts list:

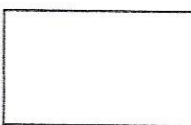
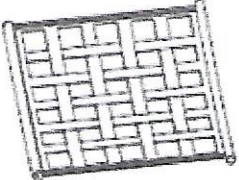
No.	PART	Q'TY	No.	PART	Q'TY
A		2	①		8
			②		8
B	 Seat	1	③		1
				Seat cushion 	
C	 Back rest	1		Back rest cushion 	

NOTES TO CUSTOMERS:

- Please check that your parcel contains all the parts listed.
- Please keep all the packaging for the product until you are satisfied with your purchase as we cannot accept any returned item not in the original packaging.
- For the protection of your furniture we recommend that the product is placed on a protected surface during assembly to prevent any damage.
- Please ensure that you read the instructions before assembling the product.
- Please do not force or over tighten the nuts. If a nut becomes stuck, unscrew it and start again.
- Ensure you have plenty of space to assemble the item in, it is also recommended that you assemble the item close to where it will be kept.
- Please ensure that you have sufficient space and people to assemble the item.
- CARE AND MAINTENANCE

- This set has been tested for a maximum load of 260kg static weight only.
- Please ensure that all components are fitted correctly before use of the Seat.
- Under no circumstances should you abruptly sit or jump on the Seat.
- Do not stand or kneel on the seat.
- Make sure all the screws and bolts are tightened properly.
- Periodically check all fixings to ensure they remain secure.
- Prolonged exposure to the elements will inevitably lead to weathering – store away indoors throughout winter to preserve appearance.
- Clean using a mild detergent – do not use abrasive cleaners
- When sitting in the chair do not lean back and put excessive pressure on the back rest causing the chair to tip.
- Keep all four chair legs on the floor when in use.

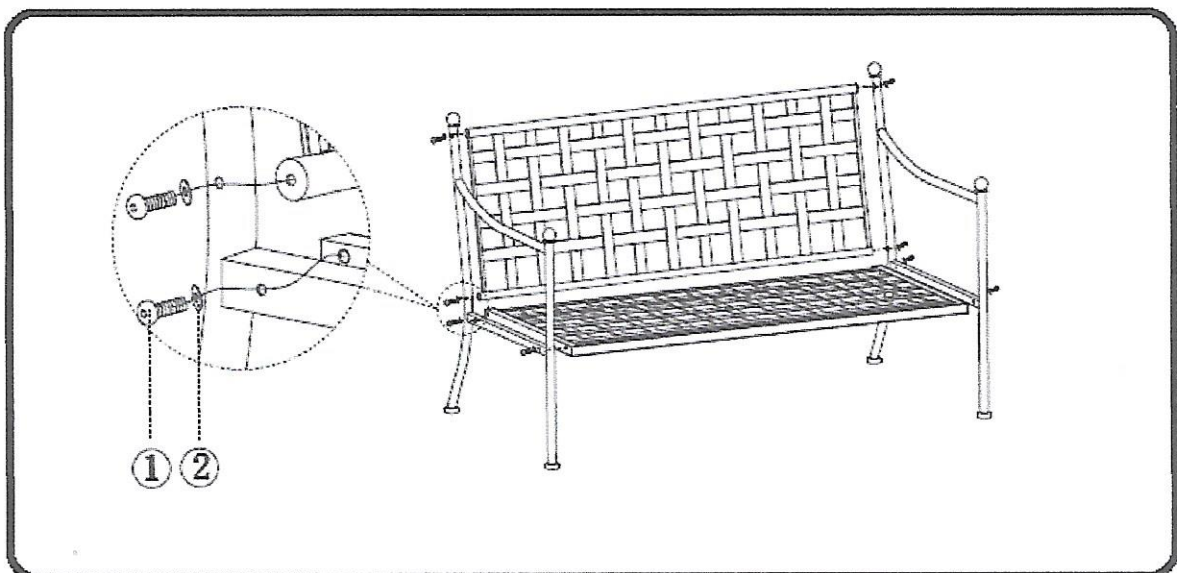

- Starting with one of the bench legs, line up the location holes with either the chair back or the seat location holes.
- Carefully push a Part 1 through the hole until it greets the location socket hole. Loosely tighten the two together
- Repeat for the other three screws and location holes.
- Turn the bench round and repeat for the other arm.

For further advise, or request for spare parts

Please contact our customer service department on 01562 753040