

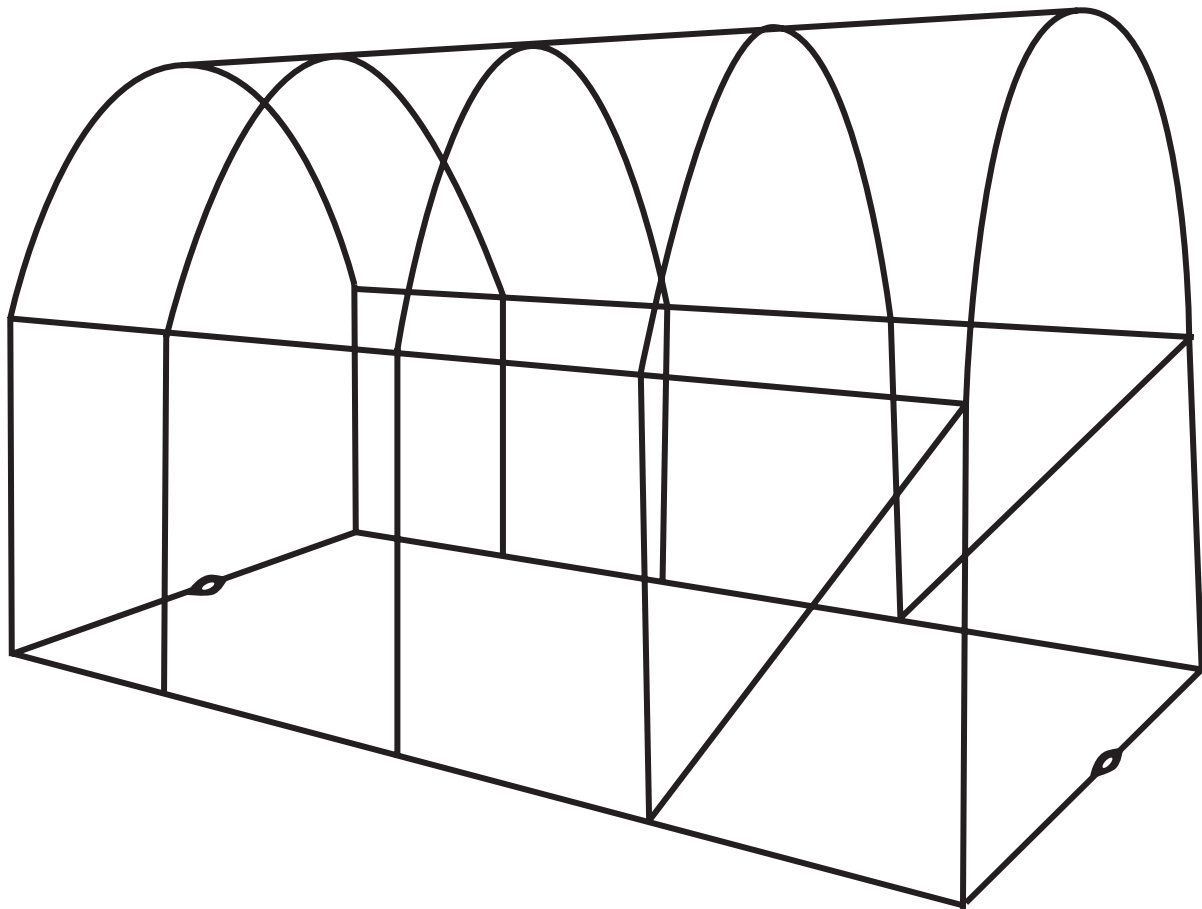

# New Leaf™ Polytunnels

## **GH2011 4m x 2m New Leaf Polytunnel Instructions**



# Assembly Instructions

Thank you for purchasing a New Leaf Polytunnel. If you have any problems please call our Customer Support Service on 0118 903 5210 or email us at [info@primrose.co.uk](mailto:info@primrose.co.uk)

## Parts List

### Before You Start

Please check that all components are present, and read through these instructions carefully.

### Part No:

1	x5	1	2	3	4	5	6	7	8
2	x5								
3	x10								
4	x5								
5	x15								
6	x2								
7	x2								
8	x2								
9	x2								
Nuts & Bolts	x25								

### Tools Needed

10mm Spanner

Phillips Screwdriver



**Important:** Always ensure bolt heads are facing outwards and nuts facing inwards to avoid polytunnel cover snagging on frame.

## Instructions

1. Layout and Check all parts are present and correct before beginning assembly



2. Connect both sets of parts 6 and 7 together
3. Lay the parts out on the ground as shown below:

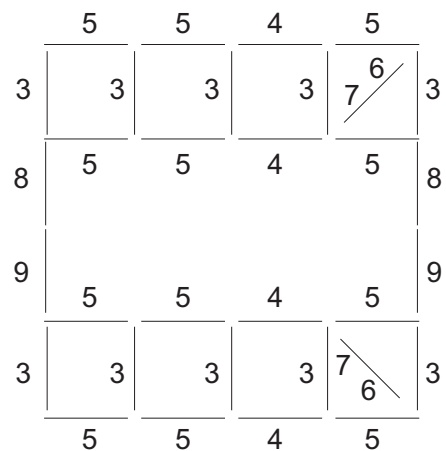

Please call our customer service line from 9-5pm, Monday-Friday if you require anymore information.

**0118 903 5210**

# Assembly Instructions

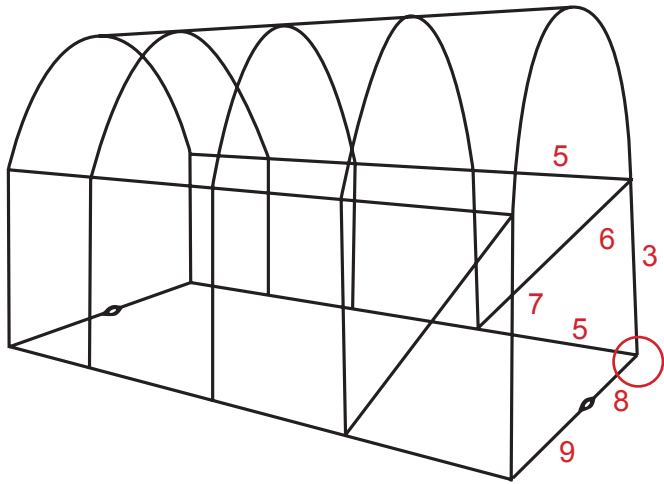

4. Starting at the corner you wish to use as the front of the tunnel, connect parts 8, 5 and 3 together.

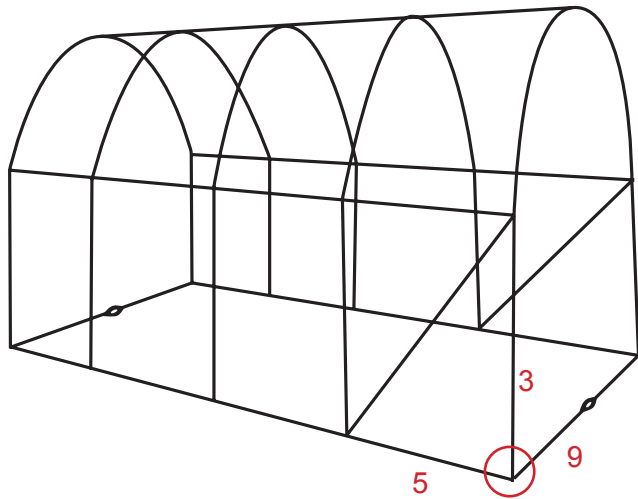

5. Repeat on opposite side connecting parts 9, 5 and 3 together.

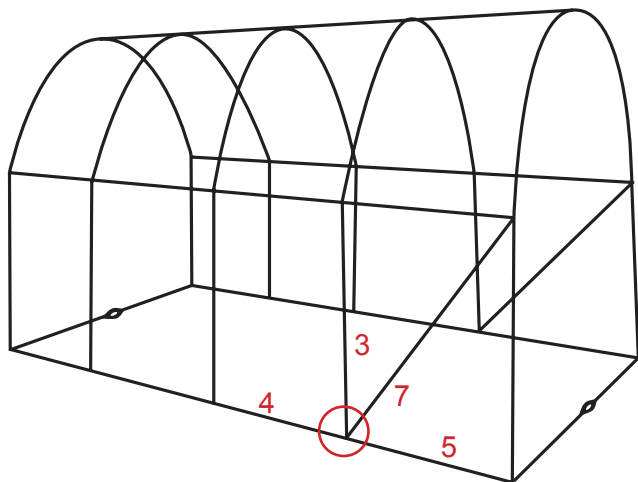

6. Next work your way along the base connecting parts 3 and 5/4 together. The second joint in from the front of your greenhouse should also have part 7 connected.



# Assembly Instructions

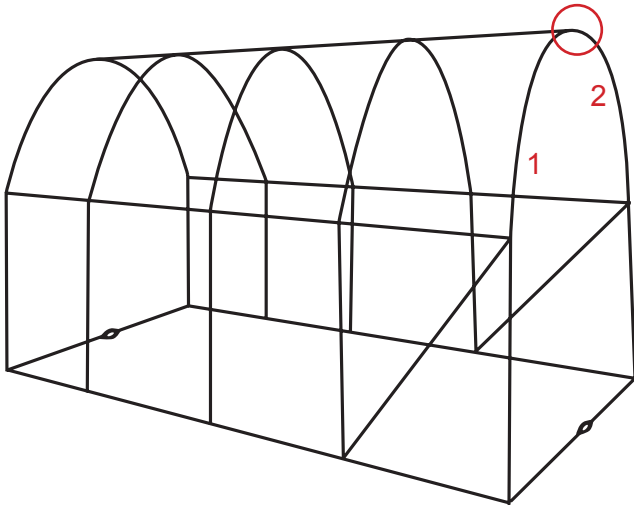

7. Connect all part 1's and 2's by slotting together and pushing bolt through (head of bolt should be at the top). Do not put nut in place just yet.



8. Starting from the same corner as earlier, now working midway up the frame, connect parts 1 and 3 together and bolt to 7 and 5.

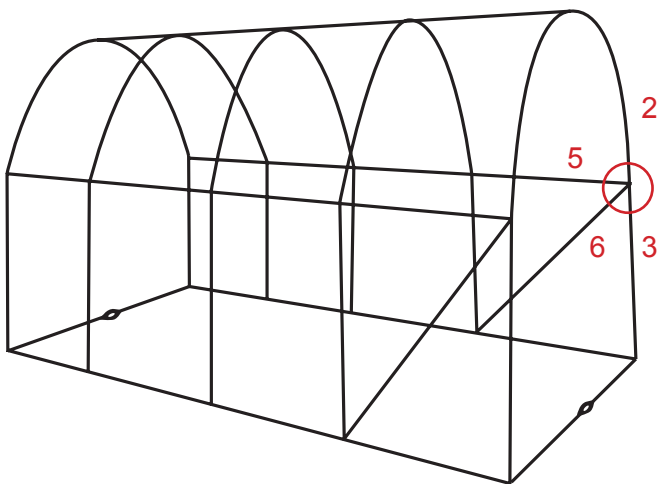

9. Repeat at opposite side connecting parts 2 and 3 together and bolting to 7 and 5.

10. Work your way down the polytunnel attaching parts 3 to parts 1/2 and bolting together with parts 4/5.

# Assembly Instructions

11. Your polytunnel should now be taking shape. Now working from the very top level. Attach the remaining parts 4 and 5 together and bolt them to the joints between parts 1 and 2.



12. Unfold the cover and undo the door zip.



13. Working from back to front, pull the cover over the frame being careful not to snag it as you go.



14. IMPORTANT!!! Make sure the corners of the polytunnel cover line up with the frame before trying to zip up as if this isn't done it can strain and break the zip.



15. Attach all Velcro and Ties to frame



An additional instructional video is available, visit [www.primrose.co.uk](http://www.primrose.co.uk) and search GH2011.